

dji OSMO POCKET 4

User Manual

v1.0 2026.04





This document is copyrighted by DJI with all rights reserved. Unless otherwise authorized by DJI, you are not eligible to use or allow others to use the document or any part of the document by reproducing, transferring or selling the document. Only refer to this document and the content thereof as instructions to operate DJI products. The document should not be used for other purposes.

In the event of divergence among different versions, the English version shall prevail.

Searching for Keywords

Search for keywords such as “battery” and “install” to find a topic. If you are using Adobe Acrobat Reader to read this document, press Ctrl+F on Windows or Command+F on Mac to begin a search.

Navigating to a Topic

View a complete list of topics in the table of contents. Click on a topic to navigate to that section.

Printing this Document

This document supports high resolution printing.

Using this Manual

Legend

⚠ Important

💡 Hints and Tips

📖 Reference

Read Before Use

DJI™ provides you with tutorial videos and the following documents:

1. *Safety Guidelines*
2. *Quick Start Guide*
3. *User Manual*

It is recommended to watch all the tutorial videos and read the *Safety Guidelines* before using for the first time. Make sure to review the *Quick Start Guide* before using for the first time and refer to this *User Manual* for more information.

Video Tutorials

Go to the address below or scan the QR code to watch the tutorial videos, which demonstrate how to use the product safely:



<https://www.dji.com/osmo-pocket-4/video>

Contents

Using this Manual	3
Legend	3
Read Before Use	3
Video Tutorials	3
1 Product Profile	6
1.1 Overview	7
1.2 Handle With 1/4" Thread	9
1.3 Battery Handle	10
1.4 Fill Light	12
1.5 Wide-Angle Lens	14
1.6 Osmo Mini Tripod	14
2 Getting Started	15
2.1 Powering On	15
2.2 Activation	15
2.3 Firmware Update	16
2.4 Charging	16
3 Basic Operations	18
3.1 Button Features	18
3.2 Operating the Touchscreen	19
Camera View	19
Swipe Up - Parameters Settings	20
Swipe Left - Image and Audio Settings	20
Swipe Right - Playback	21
Swipe Down - Control Center	21
4 Using the Product	25
4.1 Setting the Shooting Mode	25
4.2 Selecting the Gimbal Mode	25
4.3 ActiveTrack	26
4.4 Smart Gimbal Mode	27
4.5 Webcam Mode	28
4.6 Footage Storage and Transfer	28
Storage Space	29
Transferring Files	29
Transferring Files to a Mobile Device	29
Transferring Files to a Computer	29
4.7 Usage Notes	30

	Battery	31
5	Specifications	32

1 Product Profile

Different combos include different accessories. The accessories can be purchased separately. Visit the [official store](#) for a full list of compatible accessories.

Accessories	Standard Combo	Creator Combo	Essential Combo
Osmo Pocket 4 Gimbal Clamp (hereinafter referred to as "gimbal clamp")	✓	✓	-
Osmo Pocket 4 Handle With 1/4" Thread (hereinafter referred to as "handle with 1/4" thread")	✓	✓	✓
Osmo Pocket 4 Fill Light (hereinafter referred to as "fill light")	-	✓	-
Osmo Mini Tripod	-	✓	-
Osmo Pocket 3 Wide-Angle Lens	-	✓	-
Osmo Pocket 4 Battery Handle (hereinafter referred to as "battery handle")	-	-	-

1.1 Overview

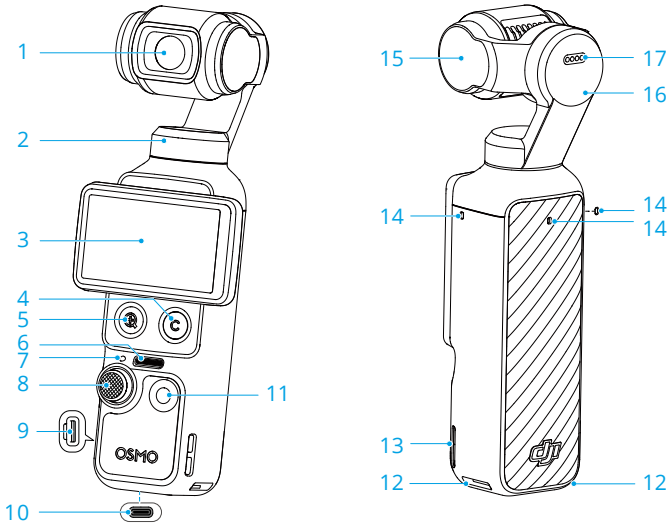

1. Camera
2. Pan Motor
3. Rotatable Touchscreen
4. Custom Button
5. Zoom Button
6. Speaker
7. Status LED

Blinking Pattern	Descriptions
Solid green	Ready to use
Temporarily off and stays green	Taking a photo
Blinks red slowly	Recording a video
Blinks red three times rapidly	Powering off, or about to power off because of low battery
Blinks red and green alternately	Updating firmware

8. 5D Joystick
9. microSD Card Slot (with cover)

 The microSD card slot cover is not waterproof. DO NOT forcefully pull the cover.

10. USB-C Port

11. Shutter/Record Button

12. Quick-Release Slot

13. Lanyard Hole

14. Microphones

 For better audio quality, DO NOT block the microphones when recording video.

15. Tilt Motor

16. Roll Motor

17. Contacts

 Ensure the contacts are clean and dry before attaching any accessories.

1.2 Handle With 1/4" Thread

Attach the handle with 1/4" thread to the camera for a more comfortable grip.

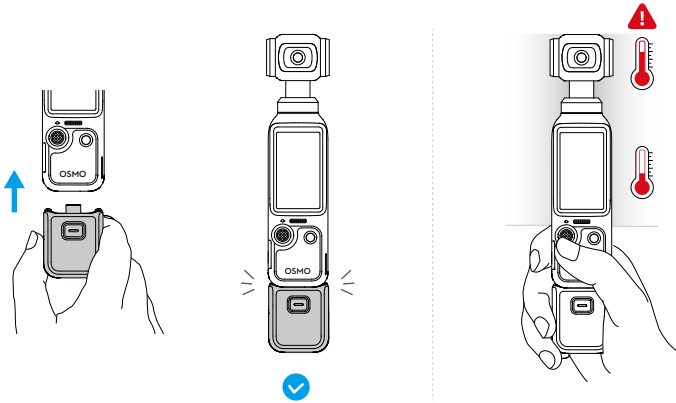

- ⚠ • After shooting high-specification videos for an extended period, the upper part of the product may become hot. DO NOT hold too high to avoid high temperatures. The camera will stop shooting if any overheating is detected.
- The handle is not waterproof. DO NOT drop it in water. Avoid spilling any liquid on the handle.

When detaching, press and hold the release button on the handle and unplug the handle.

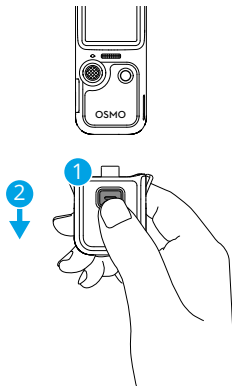

1.3 Battery Handle

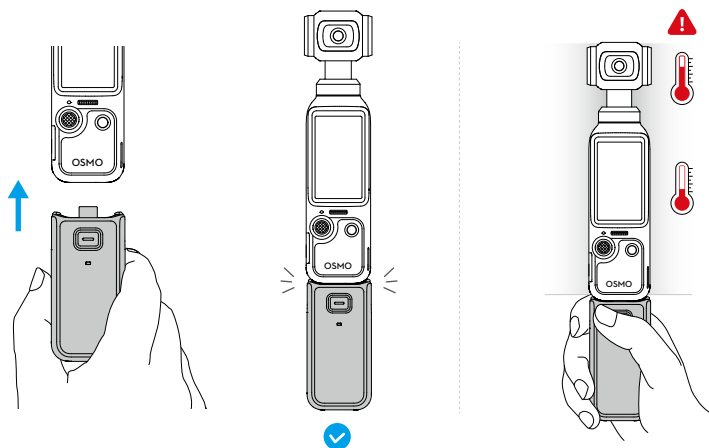

- ⚠ • After shooting high-specification videos for an extended period, the upper part of the product may become hot. DO NOT hold too high to avoid high temperatures. The camera will stop shooting if any overheating is detected.
- When the battery handle is mounted to the camera, its firmware will be updated automatically during the camera firmware update. A prompt will appear on the camera when the update is successful. DO NOT remove the battery handle before the update is complete.
- Make sure the battery handle has power when used with external audio devices.
- Make sure the battery handle is properly insulated to prevent fire hazards. DO NOT drop or strike the battery handle.
- If foreign object is obstructing the USB-C port, use an air blower, soft brush, or other tools to clean the USB-C port and remove the foreign object. Note to sweep from the inside of the port to the outside.
- The handle is not waterproof. DO NOT drop it in water. Avoid spilling any liquid on the handle.
- Discharge the battery handle to 50% battery level if it is not used for 10 days or more in order to extend the battery life.

When detaching, press and hold the release button on the battery handle and unplug the handle. After the battery handle is detached, press the release button once to check the battery level using the status LED.

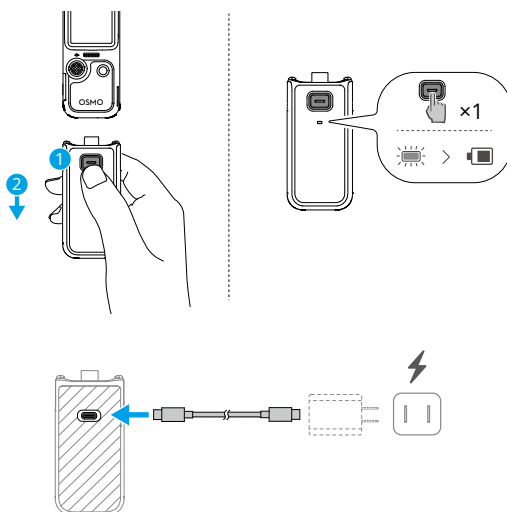

⚠ Before charging, make sure the ports are clean and dry. Clean the ports with a dry cloth if there is any noticeable build up.

Status LED

Battery Level Status

Solid red for 3s and turns off	1% - 19%
Solid yellow for 3s and turns off	20% - 49%
Solid green for 3s and turns off	50% - 100%
Blinks red three times	0%

Battery Level Status During Charging

Blinks green four times	> 75%
Blinks green three times	51% - 75%
Blinks green twice	26% - 50%
Blinks green	0% - 25%
Off	Charging completed

System Status

Blinks red and green alternately	Updating firmware
----------------------------------	-------------------

Blinks red twice

The ambient temperature is abnormal, and the battery handle cannot be used at this time. Wait until the temperature returns to normal.

Blinks yellow

Firmware update failed (connect to the camera and try update again)

1.4 Fill Light

Attach and adjust the angle:

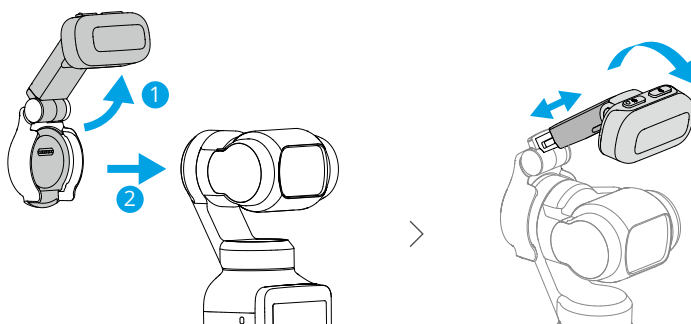

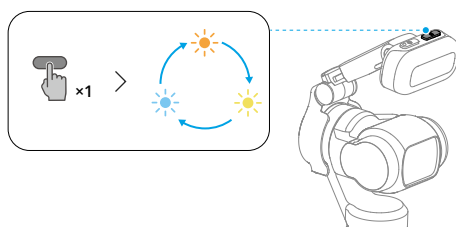

Adjust color temperature:

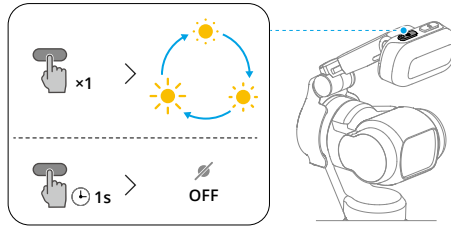

Adjust brightness or turn off the fill light:



- Enter the Control Center and tap  to quickly turn the fill light on or off. Tap  > **Fill Light** to enable auto-on feature for selfies or low-light conditions, and to adjust the brightness and color temperature.

- ⚠ • This product contains magnets. Keep the product away from magcards, implantable medical devices such as pacemakers, hard disks, RAM chips, and other devices to avoid interference.
- Before attaching the fill light, clean the contacts with a dry cloth if there is any noticeable buildup.
- When attaching the fill light, make sure it is correctly aligned with the gimbal to ensure a secure attachment.
- Avoid excessive shaking or sudden movements to prevent the fill light from falling.
- When installing or using the fill light, avoid collisions between the fill light and the gimbal camera.
- Before storing the camera, remove the fill light first, then power off the camera.

1.5 Wide-Angle Lens

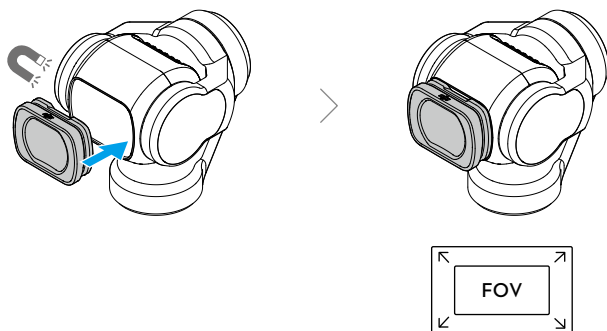

- ⚠ • The wide-angle lens is not suitable for panoramic photography.
- Keep the camera lens and both sides of the wide-angle lens clean. Dust or sand may scratch the lens and result in the wide-angle lens falling off.
- Before storing the camera, remove the lens first, then power off the camera.

1.6 Osmo Mini Tripod

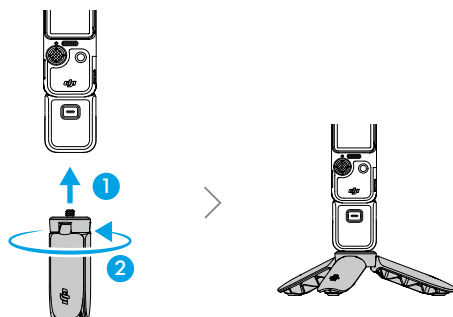

2 Getting Started

2.1 Powering On

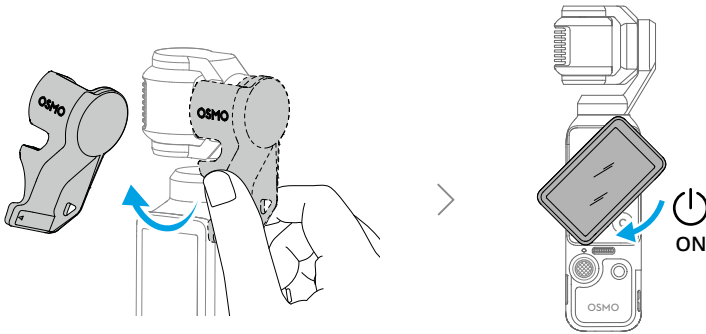

- When not recording, press and hold the Shutter/Record button or rotate the touchscreen counterclockwise to power off. To keep the camera on after rotation, swipe down in the camera view to open the Control Center, tap  > **Rotate screen to power off** to modify the settings.
- The camera has 107 GB of usable storage and supports microSD cards for storage expansion. Refer to [Specifications](#) for the recommended microSD cards.

2.2 Activation

Make sure to activate the camera using DJI Mimo App before first use.

1. Scan the QR code on the screen to download the DJI Mimo App.
2. Enable Wi-Fi and Bluetooth on the mobile device.
3. Launch DJI Mimo App on the mobile device, tap the camera icon to connect to the camera, and then follow the instructions to activate the camera.

When the camera is used with the DJI Mimo App, you can monitor the current camera view, set the camera parameters, and control the camera with a mobile device.

- To check the Android and iOS operating system versions supported by the app, visit <https://www.dji.com/downloads/djiapp/dji-mimo>.

- The interface and functions of the app may vary as the software version is updated. Actual user experience is based on the software version used.

💡 If there is a problem when connecting to DJI Mimo App, follow the steps below:

1. Make sure both Wi-Fi and Bluetooth are enabled on the mobile device.
2. Make sure the DJI Mimo App has the latest firmware version.
3. In the liveview, swipe down from the top of the screen and tap **⚙ > Wireless Connection > Reset Connection**. The camera will reset all connections and Wi-Fi passwords.

2.3 Firmware Update

A prompt will appear in DJI Mimo App when new firmware is available. Tap the prompt and follow the on-screen instructions to update the firmware.

💡 If the update fails, follow the steps for troubleshooting.

1. Restart the camera and DJI Mimo App.
2. Enable Wi-Fi and Bluetooth on the mobile device.
3. Connect the camera to DJI Mimo App and try the update again.

Contact DJI Support if the update fails again.

2.4 Charging

Use the provided cable to connect the USB-C port to a charger. It is recommended to use a USB-C PD charger.

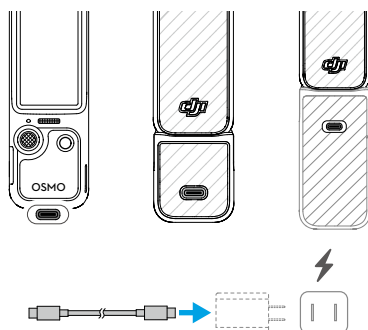

 If the battery handle is mounted, the battery handle will not start charging until the battery of the handheld gimbal camera is fully charged.

 Before charging, make sure the ports are clean and dry. Clean the ports with a dry cloth if there is any noticeable build up.

3 Basic Operations

3.1 Button Features

5D Joystick

Push left or right: Control the camera movement in the pan axis.

Push up or down: Control the camera tilt or zoom.*

* The amount of joystick movement controls the gimbal rotation speed and camera zoom speed. The further the joystick is pushed, the faster the gimbal camera rotates or zooms. To disable this feature, swipe down from the top of the camera view, tap  and enable **Input Lock**. This setting allows for stable zoom control.

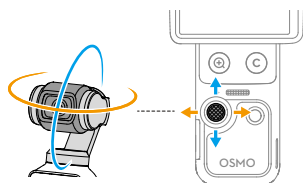

Press once: Go back to the previous menu, or exit ActiveTrack.

Press twice: Recenter the gimbal.

Press three times: Switch the camera between facing forward and backward.

Press and hold: Lock the gimbal.



Shutter/Record Button

Press once in the camera view: Take a photo or start/stop recording.

Press once when powered off: Power on.

Press and hold: Power off.



Zoom Button

Press once: Switch to 2x zoom.

Press twice: Switch to 4x zoom.*

* Only supported in certain shooting modes.

Press once at any zoom level to switch back to 1x zoom.



Custom Button

Press and hold: Customize the button functions.

By default:

Press once: Switch joystick control of gimbal tilt or camera zoom.

Press twice: Recenter the gimbal.

Press three times: Lock/unlock the gimbal.

3.2 Operating the Touchscreen

Camera View

After the camera powers on, the touchscreen shows the liveview.

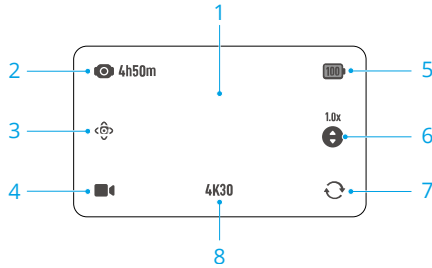

1. Single tap in the camera view to focus and meter. Double tap to select an [ActiveTrack](#) subject.
2. Storage Capacity/Remaining Recording Time
3. [Smart Gimbal Mode](#)
4. [Setting the Shooting Mode](#)
5. Battery Level

When the battery handle is mounted, tap the icon to view the battery levels of both the camera and the battery handle.
6. Switching Joystick Control

Tap to switch joystick control of gimbal tilt or camera zoom.
7. Gimbal Rotate

Tap to switch the camera between facing forward and backward.
8. Shooting Specifications

Swipe Up - Parameters Settings

Swipe up from the bottom of the screen to set the parameters for each shooting mode. Once you have set the parameters, swipe down from the top of the screen to return to the liveview.

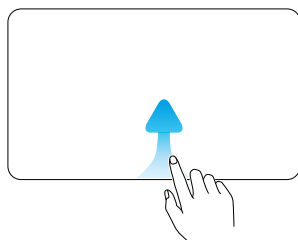

-
- 💡 • Various parameters can be set in different shooting modes. Refer to the actual interface.
-

Swipe Left - Image and Audio Settings

Swipe left in the camera view to adjust image and audio settings. Tap **PRO** to adjust pro parameters.

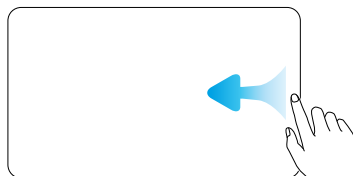

-
- 📖 D-Log 10 bit is designed for professional color grading when post-editing. In high-contrast or multi-color scenarios (e.g., garden, field, etc.), it can enlarge the dynamic range for more color-grading in post-production. When D-Log 10bit color mode is selected, you can enable Color Recovery to preview the color rendering in the camera view.
-

- 💡 Focus Mode, Beautify, App Glamour Effects, Film Tone and other settings are also supported. Click to watch the [tutorial video](#). Film Tone and Beautify are only available in Video mode and cannot be used simultaneously.
-

Swipe Right - Playback

Swipe right from the screen to view the last taken footage.

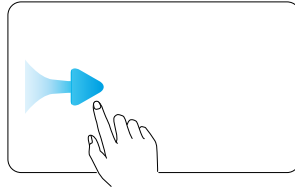

When playing back the video, long press any blank area on the screen to play at double speed. During playback, swipe left from the right edge of the screen to return to the liveview.

Swipe Down - Control Center

Swipe down from the top of the screen to enter the control center. Swipe up from the bottom of the screen to return to the liveview.

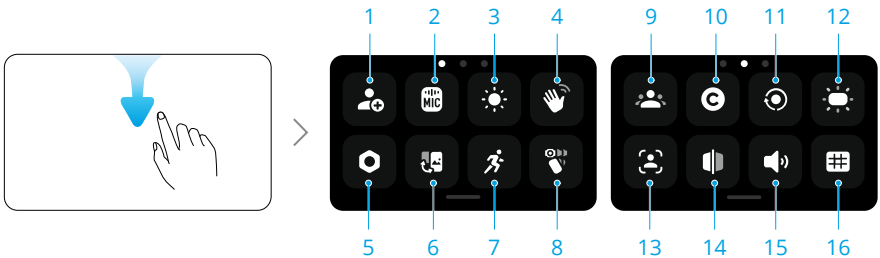

1. Custom Mode

Save the current shooting settings as a custom mode. Custom modes can then be used directly to shoot similar scenes.

2. Wireless Microphone

The camera can connect to two DJI wireless microphone transmitters simultaneously. Visit the official website to view the supported models.

Follow the on-screen instructions for linking. Once linked, you can use the transmitter to control the camera to start recording, with the audio being captured by the transmitter.



- Visit the DJI website and refer to the user manual of the mic product for more information.



- When the transmitter is linked to the camera, tap **Wireless Microphone** settings to adjust the audio parameters of the transmitter.
 - Enter the control center, tap  and enable **Audio Backup**. When enabled, the camera's built-in microphone will also record audio simultaneously while recording video with a wireless microphone. This backup audio can be saved as a separate .aac file or embedded as an additional audio track in the video file. Audio Backup is not supported in Timelapse, Webcam, and DisplayPort transmission modes.
-

3. Brightness

Tap and slide to adjust the brightness. You can also enable adaptive brightness for outdoor use.

4. Gesture Control

When enabled, face the camera and perform the corresponding gesture to take photos, record videos, or control ActiveTrack:

- Palm  : Enable/disable ActiveTrack.
 - V Gesture  : Take a photo, or start/stop video recording.
-

-  • To ensure optimal gesture control, perform and hold the gesture within 2 meters of the camera and avoid blocking your head. There will be an on-screen prompt when the gesture takes effect.
 - When **Registered Subjects Only** is enabled, only registered subjects can control the camera with gestures.
-

5. Settings

Gimbal Calibration, Auto Power Off and other settings are also supported. Key features are as follows:

Gimbal Start-up Direction	Set the direction the camera faces when powered on. Last Setting: if the gimbal mode is set to Follow or Tilt Locked, the camera will face forward or backward. If the gimbal mode is FPV, the camera will rotate to resume the same orientation when powered off last time.
Wearable Mode	After enabled, the camera will rotate and lock in the selfie mode and the gimbal mode will change to Tilt Locked. Tap twice on the screen to recenter the gimbal. Swipe up to exit Wearable mode. In wearable mode, it is recommended to use the camera with the Expansion Adapter (sold separately).

Anti-Flicker	Tap to select the anti-flicker frequency to reduce flicker caused by fluorescent lights or TV screens when shooting indoors. Select the anti-flicker frequency according to the power grid frequency in the region. The default anti-flicker frequency is set as Auto.
Timecode	Either reset the timecode or sync with the system time. The camera timecode can be synchronized by a time code synchronizer using the USB-C port. Tap Timecode Display to display the time code in the liveview.

6. Switching between Landscape and Portrait Mode

Tap and select the shooting orientations: Auto-Rotation, Landscape, and Portrait.

7. Rotational Speed

Tap to adjust the gimbal following speed.

8. Selecting the Gimbal Mode

9. Register Subject

Register and manage the subject. Registered subjects can be prioritized for autofocus, gesture control, and Spotlight Follow.

10. Custom Button

Customize the button functions.

11. Screen Rotate & Capture

When this function is enabled, footage shooting will be started as soon as you rotate the touchscreen clockwise to power on the camera. Last Settings are used by default.

- ☀️ • After shooting, the camera will automatically power off if left idle for two seconds.
- When you rotate the screen again during recording:
 - If the shooting orientation is set to Auto-Rotation or Landscape, the recording stops and the camera will power off after two seconds.
 - If the shooting orientation is set to Portrait, shooting will continue.

12. Fill Light Switch

13. FT (Selfie)

When the gimbal is in selfie orientation, the camera automatically tracks the subject occupying the largest area of the frame. Tracking stops when the gimbal orientation is reversed.

14. Selfie Flip

When enabled, footage captured in selfie mode is automatically mirrored to match the preview.

15. Sounds

Tap to set volume.

16. Reference Lines

Display reference lines in the camera view to assist with composition.

4 Using the Product

4.1 Setting the Shooting Mode

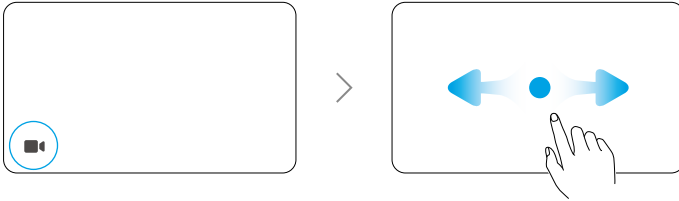

1. Tap the icon to enter the mode switch page.
2. Swipe to select a shooting mode.
3. Tap the selected shooting mode or swipe up from the bottom of the screen to return to the liveview.

4.2 Selecting the Gimbal Mode

Swipe down from the top of the screen to enter the control center. Tap the icon to select the gimbal mode. Click to watch the [tutorial video](#).

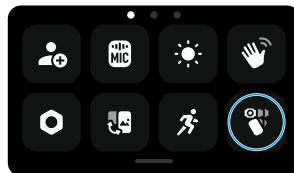

Follow

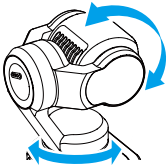

The pan and tilt axis follow the handle while the roll axis remains level.

Follow mode is selected by default and is suitable for most scenarios, including vlogs and selfie.

Tilt Locked



Only the pan axis follows while the tilt axis is locked and the roll axis remains level. This mode is suitable for push-in/pull-out and lateral movement shots.

The camera rotates freely and follows the handle movement. This mode is suitable for creative shots or immersive first-person view footage.

FPV / FPV ⊥

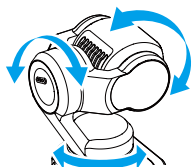

FPV

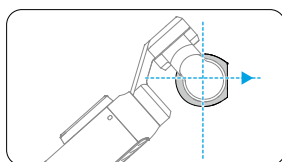

The camera keeps horizontally forward when powering on or re-centering.

FPV ⊥

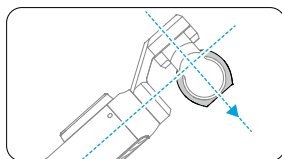

The camera keeps perpendicular to the handle when powering on or re-centering.

4.3 ActiveTrack

When in Photo or Video mode, tap twice on the touchscreen to select a subject and enable ActiveTrack. At this time, the gimbal camera will automatically follow the selected subject. Press the 5D joystick or tap the touchscreen to exit ActiveTrack.

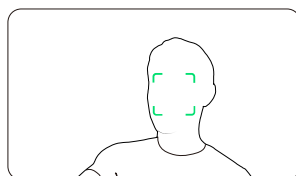

⚠ ActiveTrack is unavailable in Panorama, Timelapse, Motionlapse, SpinShot, or when using FPV mode with the camera held horizontally.

4.4 Smart Gimbal Mode

In Video mode, tap the icon to select the smart gimbal mode and tap again to exit.

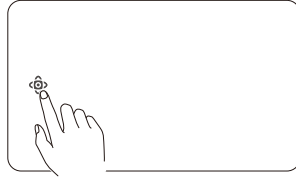

Spotlight Follow

After recording starts, the camera prioritizes following the registered subjects. If no subject is registered, the camera will automatically follow the subject closest to the center of the frame.

Dynamic Framing

Select the subject position in the live view based on the golden ratio or the rule of thirds via the 5D joystick. After the subject enters the frame, press the joystick to track the subject while keeping the subject at the selected position.

SpinShot

Press the joystick once or tap the icon on the screen to start SpinShot mode. The camera will rotate 90° or 180° to capture footage, creating a distinctive cinematic effect.

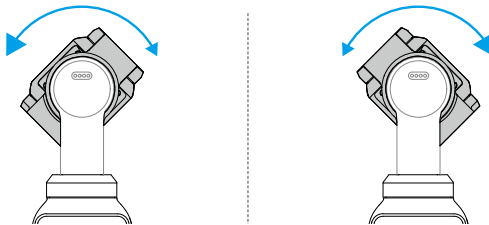

90°

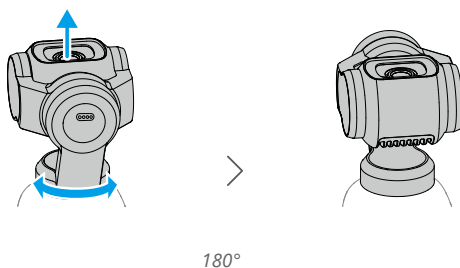

4.5 Webcam Mode

The product can work as a webcam on a computer. Power on the product and connect it to the computer using a USB cable. Tap **Webcam** on the camera to enter the Webcam mode, and the camera will function as a webcam input device. The bottom of the screen displays Webcam.

Press the Shutter/Record button to start recording. Users can preview recorded videos after exiting the Webcam mode.

 Ensure that the device is adequately cooled during use. Disconnect the device promptly after shooting is completed.

4.6 Footage Storage and Transfer

-
-  • To ensure a secure connection, it is recommended to use the provided data cable. If using third-party cables, select safe and reliable ones to ensure device performance and safety.
- Ensure that the microSD card slot and the microSD card are clean and free of foreign objects during use.
 - DO NOT remove the microSD card during recording. Otherwise, the microSD card may be damaged and cause data loss.
 - Before shooting important photos or videos, shoot a few images to test whether the camera is operating correctly.
 - Make sure to back up all important data stored in the internal storage or on the microSD card. Data cannot be restored if damaged or lost. Users are responsible for any loss caused by data loss in the internal storage.
-

Storage Space

Swipe down from the top of the screen, and then swipe left to check the storage information.

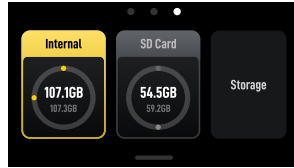

The camera has built-in storage and also supports expanding storage by installing a microSD card.

Tap **Storage** to format the internal storage or the microSD card.

⚠ Formatting will permanently delete all data. Make sure to back up all required data before formatting.

Transferring Files

- 💡 • When transferring files by cables, if the camera cannot automatically recognize the connected device, enter the control center, tap **⚙** > **USB mode**, and reconnect the camera.
-

Transferring Files to a Mobile Device

- Connect the camera to DJI Mimo App, tap the album icon to preview photos and videos. Click **↓** to download photos and videos.
- You can also transfer photos and videos by cables. Use the provided cable to connect the mobile device. When connected, view and transfer photos and videos via the device album or file management.

The photos and videos can be shared directly from DJI Mimo App to social media platforms.

Transferring Files to a Computer

Power on the camera and connect it to a computer using a USB-C cable. When connected to a computer, a pop-up will appear. Tap **Transfer File: USB** to download the files from

the camera to the computer. When transferring a file, the camera cannot take photos or record videos.

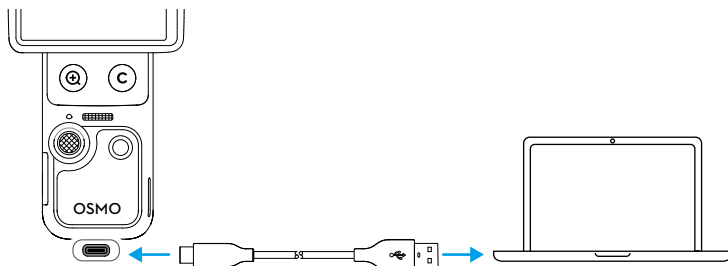

 Reconnect the device to the computer if a file transfer is interrupted.

 After file transfer is complete, **DO NOT** immediately disconnect the device to prevent data loss. Wait for the safe-to-remove prompt on your computer before disconnecting.

4.7 Usage Notes

1. Intricate components inside the device may be damaged upon impact and cause the gimbal to malfunction. Handle with care. Keep the product away from sand and dust to safeguard the device.
2. Make sure there is nothing obstructing the gimbal when the device is powered on.
3. **DO NOT** manually adjust the axis lock frequently to avoid causing the axis lock to malfunction.
4. The product is not water resistant. **DO NOT** spill any liquid on the product or use any liquid cleansers. Only use a soft dry cloth to clean the product.
5. **DO NOT** cover or touch the ventilation area of the product as it may become hot during use. When overheating, the camera will stop shooting.
6. **DO NOT** use the product in the environments with high-amplitude vibrations (such as installing on the hand bar of motorcycle or bike). Otherwise, the gimbal can be damaged.
7. Slight friction between the screen frame and the body is a normal phenomenon and does not affect use when rotating the screen.
8. **DO NOT** expose the camera lens in an environment with laser beams, such as a laser show, in order to avoid damaging the camera sensor.

9. Shaking the camera during power-on may cause startup failure. Hold the camera still while powering on.
10. After powering off the camera, attach the gimbal clamp to prevent damage caused by unintended movement. The gimbal clamp includes a lanyard hole that can be used with a strap to help prevent the clamp from being lost. **DO NOT** use the lanyard hole on the gimbal clamp to hang or support the camera, as the clamp may loosen and cause the camera to fall.

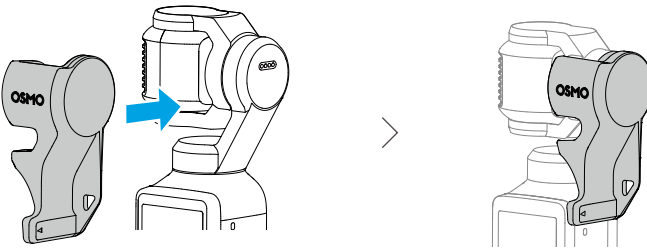

Battery

1. **DO NOT** use non-official batteries. DJI takes no responsibility for any damage caused by non-official batteries.
2. Use the battery within the temperature range specified at <https://www.dji.com/osmo-pocket-4/specs>. Use of the battery in a high-temperature environment can lead to a fire or explosion. Before using the battery in a low-temperature environment, it is recommended to charge the battery fully in a normal temperature environment. Charging the battery at the ideal temperature can prolong battery life.
3. Discharge and charge the battery completely once every three months to keep it in good condition.
4. The battery is designed to stop charging when it is fully charged. It is good practice to monitor the charging progress and disconnect the charger when battery is fully charged.
5. When the battery voltage is too low, the battery will enter low-power state. Charging the battery will exit low-power mode.
6. **DO NOT** store the battery for an extended period of time after fully discharging. Otherwise, the battery may over-discharge and cause irreparable damage to the battery cell.
7. Discharge the battery to 40-65% if it will not be used for 10 days or more. This can greatly extend the battery life.

5 Specifications

Visit the following website for specifications.

<https://www.dji.com/osmo-pocket-4/specs>



Contact
DJI SUPPORT

This content is subject to change without notice.
Download the latest version from



<https://www.dji.com/osmo-pocket-4/downloads>

If you have any questions about this document, please contact DJI by sending a message to **DocSupport@dji.com**.

DJI and OSMO are trademarks of DJI.
Copyright © 2026 DJI All Rights Reserved.